

Pendant Light Fittings BnD81 Series Explosion-proof Light Fittings

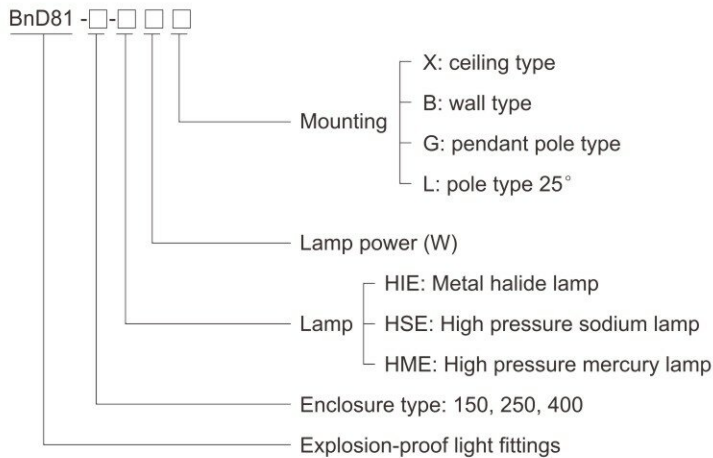

- ◆ Explosion protection to
 - CENELEC
 - IEC
 - NEC
- ◆ Can be used in
 - Zone 2
 - Zone 21 and Zone 22
 - Class I, Zone 2
 - Class I, Division 2, Groups A, B, C, D
- ◆ Available lamp (max.400W):
 - Metal halide lamp (HIE)
 - High pressure sodium lamp (HSE)
 - High pressure mercury lamp (HME)
- ◆ Three enclosure types: 150, 250, 400
- ◆ Integral control gear, easy installation and maintenance.
- ◆ Both American standard and European standard are available.

Catalogue number logic



Selection table



Type/Ordering code	Available lamp power (W)			Lamp holder	Weight (kg)	
	HIE	HSE	HME		American standard	European standard
BnD81-150	70, 100, 150	70, 100	80, 125	E27 (E26)	8.05	6.15
BnD81-250	175, 250	150, 250	250	E40 (E39)	13.00	10.20
BnD81-400	400	400	400	E40 (E39)	18.45	13.60

- Note:**
1. The light fittings are supplied without lamp. PHILIPS lamps are recommended.
 2. The light fittings are supplied without external reflector. Please specify when ordering.
 3. High pressure mercury lamp is not available in American standard products.

Zones 2; 21&22

Pendant Light Fittings

BnD81 Series Explosion-proof Light Fittings

Technical data																
Explosion-proof light fittings	BnD81-150-□□□															
Explosion protection	<p>Global (IECEX) Gas and dust</p> <p>IECEX CQM 12.0045X Ex nR IIC T4 or T3 Gc¹⁾ Ex t IIIIC T130°C or T190°C Db IP65¹⁾</p> <p>Europe (ATEX) Gas and dust</p> <p>LCIE 12 ATEX 1018X(gas)LCIE 12 ATEX 3093X(dust)  II 3 G Ex nR IIC T4 or T3 Gc¹⁾  II 2 D Ex tb IIIIC T130°C or T190°C Db IP65¹⁾</p> <p>¹⁾ See Selection table</p>															
Certificates	IECEX; ATEX; CU-TR; UL															
Conformity to standards	EN 60079-0, EN 60079-15, EN 60079-31 IEC 60079-0, IEC 60079-15, IEC 60079-31 UL 1598, CSA C22.2 No.250.0-8, UL 60079-0, UL 60079-15 CSA C22.2 No. 60079-0, CSA C22.2 No. 60079-15															
Material	<p>Enclosure</p> <p>Copper-free Aluminium Alloy, powder coated surface, yellow (RAL1021)</p> <p>Transparent cover</p> <p>Toughened glass, stands 4J impact</p> <p>External reflector (optional)</p> <p>Pure aluminium, anodic-oxidation treatment for surface</p> <p>Wire guard (optional)</p> <p>Stainless steel</p> <p>Ballast</p> <p>Electromagnetic ballast, rapid starting, stable performance</p> <p>Trigger</p> <p>General trigger</p> <p>Power factor</p> <p>COS $\phi \geq 0.90$ (compensated)</p> <p>Exposed fastener</p> <p>Stainless steel</p>															
Lamp	American Standard: E26; European Standard: E27															
Available lamp	<table border="1"> <thead> <tr> <th>Available lamp</th> <th>American Standard</th> <th>European Standard</th> </tr> </thead> <tbody> <tr> <td>HIE</td> <td>120V/208V/240V/277V/480V AC</td> <td>220~240V, 250V AC</td> </tr> <tr> <td>HSE</td> <td>70W, 100W, 150W</td> <td>70W, 100W, 150W</td> </tr> <tr> <td>HME</td> <td>70W, 100W</td> <td>70W, 100W</td> </tr> <tr> <td>HME</td> <td>-</td> <td>80W, 125W</td> </tr> </tbody> </table>	Available lamp	American Standard	European Standard	HIE	120V/208V/240V/277V/480V AC	220~240V, 250V AC	HSE	70W, 100W, 150W	70W, 100W, 150W	HME	70W, 100W	70W, 100W	HME	-	80W, 125W
Available lamp	American Standard	European Standard														
HIE	120V/208V/240V/277V/480V AC	220~240V, 250V AC														
HSE	70W, 100W, 150W	70W, 100W, 150W														
HME	70W, 100W	70W, 100W														
HME	-	80W, 125W														
Available lamp and lamp power (W)	Note: Please see Selection table of American standard HID lamp and corresponding electrical components (See P1/22)															
Rated voltage	American standard: 120V/208V/240V/277V/480V AC 60Hz (50Hz is optional) European standard: 220~240V AC 50Hz (60Hz is optional) 250V AC 50Hz (60Hz is optional)															
Earthing protection	M5 (internal & external earth bolts)															
Degree of protection	IP65															
Ambient temperature	ATEX / IECEX: -60°C~+55°C; UL: -60°C~+45°C															
Terminal	3 x 1.5~4mm ² (L+N+PE)															
Mounting	Ceiling type, wall type, pendant pole type, pole type 25°															
Cable entries	1 x M25 x 1.5															
Cable gland (optional)	DQM-I (Ex e) is recommended. Please see P7/16~19															



Selection table		Temperature classes			
Rated power (W)		-60°C ≤ Ta ≤ +40°C		-60°C ≤ Ta ≤ +55°C	
		Gas	Dust	Gas	Dust
European Standard	HIE 70W, 100W	T4	T130°C	T4	T130°C
	HIE 150W			T3	T190°C
	HME 80W			T4	T130°C
	HME 125W			T3	T190°C
	HSE 70W, 100W			T4	T130°C
American Standard	HIE 70W, 100W, 150W	T4	T130°C	T4	T130°C
	HSE 70W, 100W				

Pendant Light Fittings BnD81 Series Explosion-proof Light Fittings

Photometric data

BnD81-150-□□□(Without external reflector)



Rated luminous flux

70W High pressure sodium lamp: 6600 lm
 100W High pressure sodium lamp: 10200 lm
 80W High pressure mercury lamp: 3800 lm
 125W High pressure mercury lamp: 6300 lm
 70W Metal halide lamp: 5800 lm
 100W Metal halide lamp: 8700 lm
 150W Metal halide lamp: 13500 lm
 The data from Philips lamp

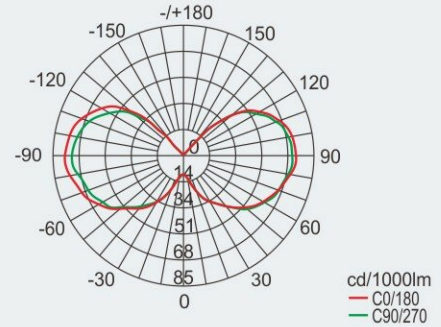

BnD81-150-□□□(With wide reflector)



Rated luminous flux

70W High pressure sodium lamp: 6600 lm
 100W High pressure sodium lamp: 10200 lm
 80W High pressure mercury lamp: 3800 lm
 125W High pressure mercury lamp: 6300 lm
 70W Metal halide lamp: 5800 lm
 100W Metal halide lamp: 8700 lm
 150W Metal halide lamp: 13500 lm
 The data from Philips lamp

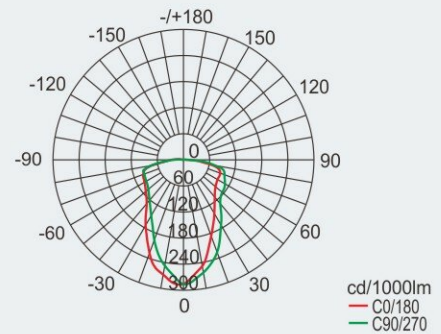

BnD81-150-□□□(With deep reflector)



Rated luminous flux

70W High pressure sodium lamp: 6600 lm
 100W High pressure sodium lamp: 10200 lm
 80W High pressure mercury lamp: 3800 lm
 125W High pressure mercury lamp: 6300 lm
 70W Metal halide lamp: 5800 lm
 100W Metal halide lamp: 8700 lm
 150W Metal halide lamp: 13500 lm
 The data from Philips lamp

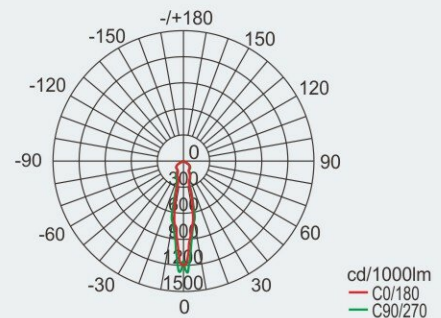

We can provide lighting design and data by professional lighting software DIALUX based upon simulated site situation on request.

Pendant Light Fittings

BnD81 Series Explosion-proof Light Fittings

Technical data												
Explosion-proof light fittings	BnD81-250-□□□											
Explosion protection												
Global (IECEX)	IECEX CQM 12.0010X											
Gas and dust	Ex nR IIC T3 Gc Ex t IIIC T190°C Db IP65											
Europe (ATEX)	LCIE 12 ATEX 1011X(gas); LCIE 12 ATEX 3044X(dust)											
Gas and dust	Ⓔ II 3 G Ex nR IIC T3 Gc Ⓔ II 2 D Ex t IIIC T190°C Db IP65											
Certificates	IECEX; ATEX; CU-TR; UL											
Conformity to standards	EN 60079-0, EN 60079-15, EN 60079-31 IEC 60079-0, IEC 60079-15, IEC 60079-31 UL 1598, CSA C22.2 No.250.0-8, UL 60079-0, UL 60079-15 CSA C22.2 No. 60079-0, CSA C22.2 No. 60079-15											
Material												
Enclosure	Copper-free Aluminium Alloy, powder coated surface, yellow (RAL1021)											
Transparent cover	Toughened glass, stands 4J impact											
External reflector (optional)	Pure aluminium, anodic-oxidation treatment for surface											
Wire guard (optional)	Stainless steel											
Ballast	Electromagnetic ballast, rapid starting, stable performance											
Trigger	General trigger											
Power factor	COS $\phi \geq 0.90$ (compensated)											
Exposed fastener	Stainless steel											
Lamp												
Lamp holder	American Standard: E39; European Standard: E40											
Available lamp and lamp power (W)	Available lamp	<table border="1"> <thead> <tr> <th>American Standard</th> <th>European Standard</th> </tr> </thead> <tbody> <tr> <td>120V/208V/240V/277V/480V AC</td> <td>220~240V, 250V AC</td> </tr> <tr> <td>HIE</td> <td>250W</td> </tr> <tr> <td>HSE</td> <td>150W, 250W</td> </tr> <tr> <td>HME</td> <td>250W</td> </tr> </tbody> </table>	American Standard	European Standard	120V/208V/240V/277V/480V AC	220~240V, 250V AC	HIE	250W	HSE	150W, 250W	HME	250W
American Standard	European Standard											
120V/208V/240V/277V/480V AC	220~240V, 250V AC											
HIE	250W											
HSE	150W, 250W											
HME	250W											
		Note: Please see Selection table of American standard HID lamp and corresponding electrical components (See P1/22)										
Rated voltage	American standard: 120V/208V/240V/277V/480V AC 60Hz (50Hz is optional) European standard: 220~240V AC 50Hz (60Hz is optional) 250V AC 50Hz (60Hz is optional)											
Earthing protection	M5 (internal & external earth bolts)											
Degree of protection	IP65											
Ambient temperature	ATEX / IECEX: -60°C~+55°C; UL: -60°C~+45°C											
Terminal	3 x 1.5~4mm ² (L+N+PE)											
Mounting	Ceiling type, wall type, pendant pole type, pole type 25°											
Cable entries	1 x M25 x 1.5											
Cable gland (optional)	DQM-I (Ex e) is recommended. Please see P7/16~19											



Pendant Light Fittings BnD81 Series Explosion-proof Light Fittings

Photometric data

BnD81-250-□□□(Without external reflector)

Rated luminous flux
 250W Metal halide lamp: 23200 lm
 250W High pressure sodium lamp: 33200 lm
 250W High pressure mercury lamp: 13000 lm
 The data from Philips lamp

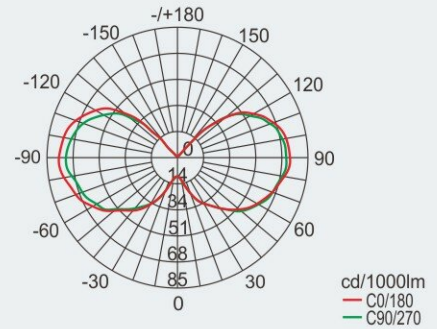

BnD81-250-□□□(With wide reflector)

Rated luminous flux
 250W Metal halide lamp: 23200 lm
 250W High pressure sodium lamp: 33200 lm
 250W High pressure mercury lamp: 13000 lm
 The data from Philips lamp

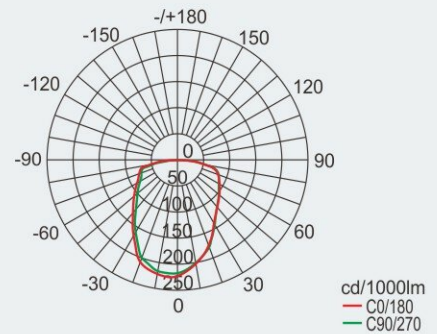

BnD81-250-□□□(With deep reflector)

Rated luminous flux
 250W Metal halide lamp: 23200 lm
 250W High pressure sodium lamp: 33200 lm
 250W High pressure mercury lamp: 13000 lm
 The data from Philips lamp

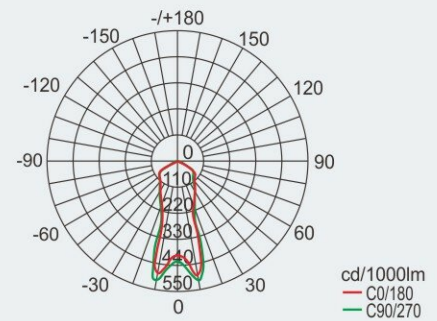

We can provide lighting design and data by professional lighting software DIALUX based upon simulated site situation on request.

Pendant Light Fittings BnD81 Series Explosion-proof Light Fittings

Technical data																									
Explosion-proof light fittings	BnD81-400-□□□																								
Explosion protection	IECEX CQM 12.0039X Ex nR IIC T□ ¹⁾ Gc Ex t IIIC T□ ¹⁾ Db IP65 LCIE 12 ATEX 1019X(gas); LCIE 12 ATEX 3094X(dust)																								
Global (IECEX) Gas and dust																									
Europe (ATEX) Gas and dust	⊕ II 3 G Ex nR IIC T□ ¹⁾ Gc ⊕ II 2 D Ex tb IIIC T□ ¹⁾ Db IP65 ¹⁾ See Selection Table																								
Certificates	IECEX; ATEX; CU-TR; UL																								
Conformity to standards	EN 60079-0, EN 60079-15, EN 60079-31 IEC 60079-0, IEC 60079-15, IEC 60079-31 UL 1598, CSA C22.2 No.250.0-8, UL 60079-0, UL 60079-15 CSA C22.2 No. 60079-0, CSA C22.2 No. 60079-15																								
Material																									
Enclosure	Copper-free Aluminium Alloy, powder coated surface, yellow (RAL1021)																								
Transparent cover	Toughened glass, stands 4J impact																								
External reflector (optional)	Pure aluminium, anodic-oxidation treatment for surface																								
Wire guard (optional)	Stainless steel																								
Ballast	Electromagnetic ballast, rapid starting, stable performance																								
Trigger	General trigger																								
Power factor	COS φ ≥ 0.90 (compensated)																								
Exposed fastener	Stainless steel																								
Lamp																									
Lamp holder	American Standard: E39; European Standard: E40																								
Available lamp and lamp power (W)	<table border="1"> <thead> <tr> <th rowspan="2">Available lamp</th> <th colspan="2">American Standard</th> <th colspan="2">European Standard</th> </tr> <tr> <th colspan="2">120V/208V/240V/277V/480V AC</th> <th colspan="2">220~240V, 250V AC</th> </tr> </thead> <tbody> <tr> <td>HIE</td> <td colspan="2">400W</td> <td colspan="2">400W</td> </tr> <tr> <td>HSE</td> <td colspan="2">400W</td> <td colspan="2">400W</td> </tr> <tr> <td>HME</td> <td colspan="2">-</td> <td colspan="2">400W</td> </tr> </tbody> </table>	Available lamp	American Standard		European Standard		120V/208V/240V/277V/480V AC		220~240V, 250V AC		HIE	400W		400W		HSE	400W		400W		HME	-		400W	
Available lamp	American Standard		European Standard																						
	120V/208V/240V/277V/480V AC		220~240V, 250V AC																						
HIE	400W		400W																						
HSE	400W		400W																						
HME	-		400W																						
	Note: Please see Selection table of American standard HID lamp and corresponding electrical components (See P1/22)																								
Rated voltage	American standard: 120V/208V/240V/277V/480V AC 60Hz (50Hz is optional) European standard: 220~240V AC 50Hz (60Hz is optional) 250V AC 50Hz (60Hz is optional)																								
Earthing protection	M5 (internal & external earth bolts)																								
Degree of protection	IP65																								
Ambient temperature	ATEX / IECEX: -60°C~+55°C; UL: -60°C~+45°C																								
Terminal	3 x 1.5~4mm ² (L+N+PE)																								
Mounting	Ceiling type, wall type, pendant pole type, pole type 25°																								
Cable entries	1 x M25 x 1.5																								
Cable gland (optional)	DQM-I (Ex e) is recommended. Please see P7/16~19																								



Selection table		Temperature classes			
Rated power (W)		-60°C ≤ Ta ≤ +40°C		-60°C ≤ Ta ≤ +55°C	
		Gas	Dust	Gas	Dust
European Standard	HIE 400W	T3	T190°C	T3	T190°C
	HSE 400W				
	HME 400W			T212°C	T212°C
American Standard	HIE 400W	T3	T190°C	T3	T190°C
	HSE 400W	T4	T130°C		

Pendant Light Fittings BnD81 Series Explosion-proof Light Fittings

Photometric data

BnD81-400-□□□(Without external reflector)



Rated luminous flux
 400W Metal halide lamp: 42000 lm
 400W High pressure sodium lamp: 56500 lm
 400W High pressure mercury lamp: 22000 lm
 The data from Philips lamp

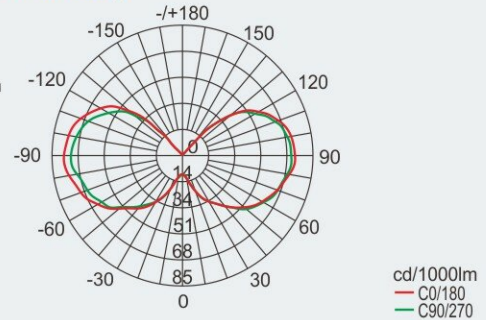

BnD81-400-□□□(With wide reflector)



Rated luminous flux
 400W Metal halide lamp: 42000 lm
 400W High pressure sodium lamp: 56500 lm
 400W High pressure mercury lamp: 22000 lm
 The data from Philips lamp

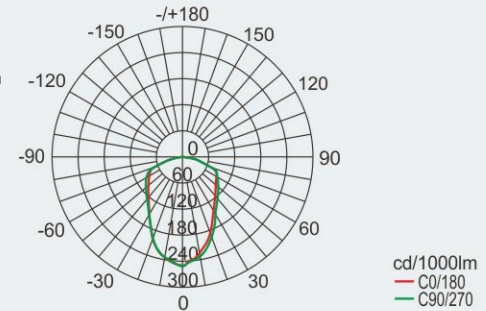

BnD81-400-□□□(With deep reflector)



Rated luminous flux
 400W Metal halide lamp: 42000 lm
 400W High pressure sodium lamp: 56500 lm
 400W High pressure mercury lamp: 22000 lm
 The data from Philips lamp

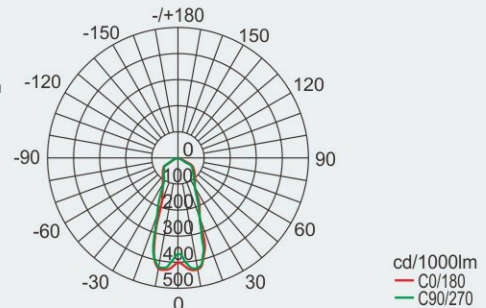

We can provide lighting design and data by professional lighting software DIALUX based upon simulated site situation on request.

Dimension drawings (all dimensions in mm) - subject to alteration

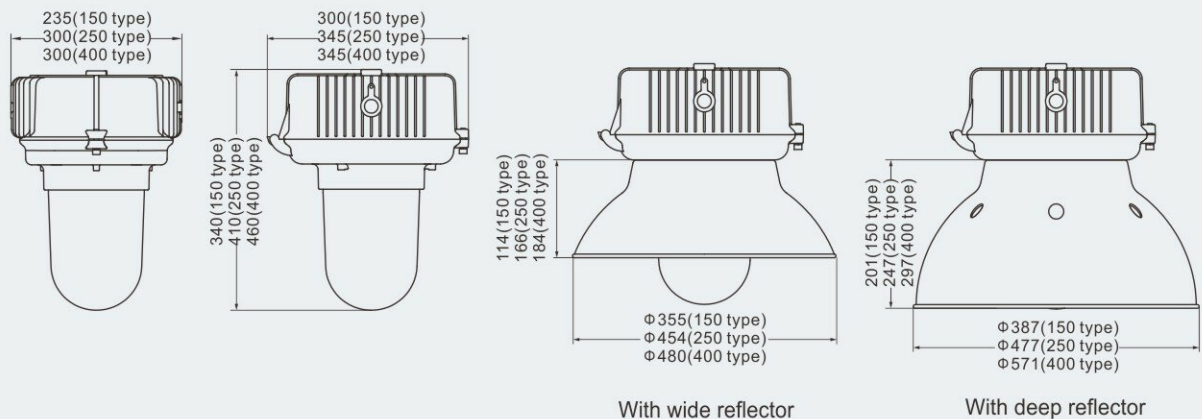

Pendant Light Fittings BnD81 Series Explosion-proof Light Fittings

Mounting type (all dimensions in mm) – subject to alteration

Installation reference

X: ceiling type

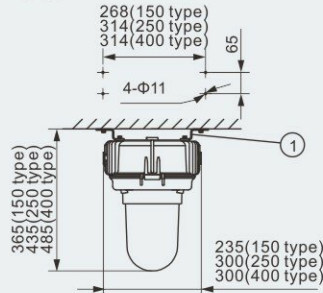

B: wall type

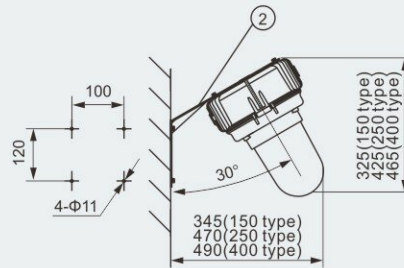

G: pendant pole type

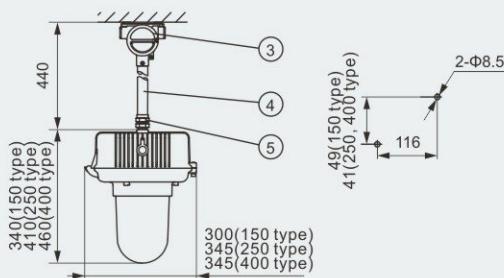

L: pole type 25°

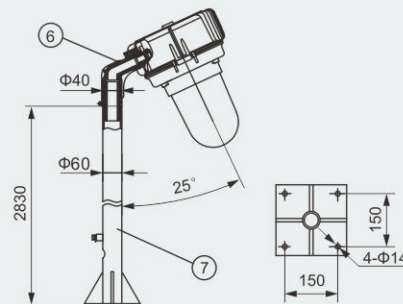

Mounting Accessories & Spare Parts Table

Supplied according to the mounting type

Mounting type	Accessories				Ordering	Weight (kg)
	Name	Qty	Illustration			
X: ceiling type	①.Mounting bracket	2	Powder coated carbon steel	81X02	0.20	
B: wall type	②.Wall bracket (powder coated carbon steel)	1	150 type	81B01	1.20	
			250 type	81B02	1.50	
			400 type	81B02	1.50	
G: pendant pole type	③.BHD51-F Explosion-proof junction box	1	150 type: copper-free aluminium 250,400 type: cast iron	BHD51-F	0.80 2.10	
	④.Straight pipe (M25 x 1.5)	1	Length: 300mm	81G01	0.41	
	⑤.BGJ-III Explosion-proof connector	1	M25 x 1.5(M) / M25 x 1.5(F) Stainless steel	81D02	0.26	
L: pole type 25°	⑥.Pole type 25° connector	1	Copper-free aluminium	81L02	0.80	
	⑦.Pole	1	Φ60mm	81L03	-	

Note: 1. Accessories not in the table shall be supplied by user.

2. Pole ⑦ shall not be supplied with light fittings; if required, please specify when ordering.

Accessories

Picture	Name	Ordering code	Weight (kg)	Picture	Name	Ordering code	Weight (kg)
	150 Wide reflector	81001	0.25		150 Deep reflector	81004	0.43
	250 Wide reflector	81002	0.35		250 Deep reflector	81005	0.63
	400 Wide reflector	81003	0.50		400 Deep reflector	81006	0.91

